

Instruction Manual

Model 4116-285-2450

Block Downconverter Weather Resistant Unit

February 2021, Rev. 0

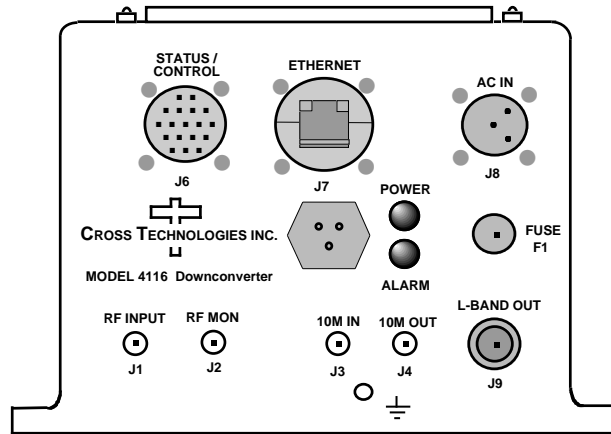

Data, drawings, and other material contained herein are proprietary to Cross Technologies, Inc., but may be reproduced or duplicated without the prior permission of Cross Technologies, Inc. for purposes of operating the equipment. Printed in USA.

When ordering parts from Cross Technologies, Inc., be sure to include the equipment model number, equipment serial number, and a description of the part.



6170 Shiloh Road

Alpharetta, Georgia 30005

(770) 886-8005 • FAX (770) 886-7964 • Toll Free 888-900-5588

WEB www.crosstechnologies.com

E-MAIL info@crosstechnologies.com

INSTRUCTION MANUAL

MODEL 4116-285-2450 Block Downconverter, Weather Resistant Unit

<u>TABLE OF CONTENTS</u>	<u>PAGE</u>
Warranty	2
1.0 General	3
1.1 Equipment Description	3
1.2 Technical Characteristics	4
2.0 Installation	5
2.1 Message Protocol	6
2.2 M&C Commands	6
2.3 M&C Queries	8
2.4 Ethernet Interface Installation	9
2.4.1 Methods of Connection	9
2.4.2 Ethernet Configuration	9
2.4.3 Web page M&C	11
2.4.4 SNMP Configuration	11
2.5 Downconverter Outline Drawings	14
2.6 Physical Interface	15
2.7 Installation/Operation	16

WARRANTY - The following warranty applies to all Cross Technologies, Inc. products.

All Cross Technologies, Inc. products are warranted against defective materials and workmanship for a period of one year after shipment to customer. Cross Technologies, Inc.'s obligation under this warranty is limited to repairing or, at Cross Technologies, Inc.'s option, replacing parts, subassemblies, or entire assemblies. Cross Technologies, Inc. shall not be liable for any special, indirect, or consequential damages. This warranty does not cover parts or equipment which have been subject to misuse, negligence, or accident by the customer during use. All shipping costs for warranty repairs will be prepaid by the customer. There are not other warranties, express or implied, except as stated herein.



6170 Shiloh Road

Alpharetta, Georgia 30005

(770) 886-8005 • FAX (770) 886-7964 • Toll Free 888-900-5588

WEBSITE www.crosstechnologies.com • E-MAIL info@crosstechnologies.com

MODEL 4116-285-2450 Block Downconverter, Weather Resistant

1.0 General

1.1 Equipment Description

The 4116-285-2450 Block Downconverter converts 28.5 - 30.0 GHz to 0.95 - 2.45 GHz. Front panel LEDs indicate DC Power and PLL Alarms. The RF to L-band gain is $+30 \pm 3$ dB maximum at F_c and is adjustable in 0.5 ± 0.5 dB steps. Connectors are 2.92 mm for RF In, RF Monitor and SMA for the external reference input and output, and Type N, female for L-band out. Gain and internal 10 MHz frequency are controlled by the Ethernet M&C. In AUTO, the 10 MHz reference stays in external if the external level is in the +2 to +8 dBm range. The unit is powered by a 100-400 $\pm 10\%$ VAC power supply, and is mounted in a 8"W X 6"H X 16"D Weather Resistant* enclosure.

NOTE: *Weather Resistant enclosures are designed to be water resistant for installation in an outdoor enclosure/antenna hut OR mounted outdoors on an antenna assembly at their specified temperature ranges. They are designed to be located "out in the elements" (water, sleet, snow, etc.) but they are *not* designed to be "submerged under water". If an extended temperature range is required, there is an **Extended Temperature Option** (Option W21; -30°C to +60°C) available at an additional cost. Contact Cross for quote.

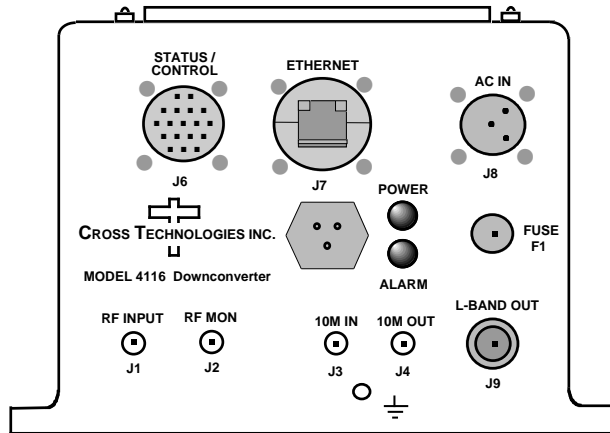

Model 4116-285-2450 Block Downconverter, Front Panel

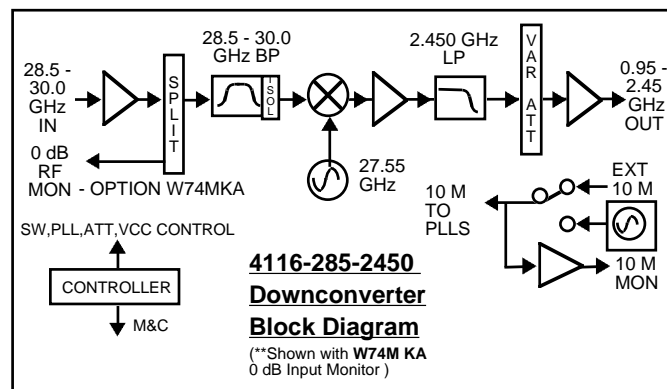

FIGURE 1. Model 4116-285-2450 Block Downconverter, Block Diagram

1.2 Technical Characteristics

TABLE 1.0 4116-285-2450 Block Downconverter Specifications*

Input Characteristics					
Impedance/Return Loss	50Ω/14 dB				
Frequency (GHz)	28.5 to 30.0 GHz				
Noise Figure, Max.	20 dB maximum gain				
Input Level Range	-50 to -30 dBm				
Output Characteristics					
Impedance/Return Loss	50Ω/14 dB				
Frequency	0.95 to 2.45 GHz				
Output Level Range	-20 to 0 dBm				
Output 1 dB Comp.	+10 dBm, maximum gain, at F _c , G _{max}				
Channel Characteristics					
Gain, max. at F _c	+30 ±3 dB, (+30 to 0 dB variable in 0.5 ±0.5 dB steps)				
Image Rejection	> 60 dB, minimum				
Spurious, Inband	SIG. REL. <-50 dBC, -20 to 0 dBm out; 2XF _o <-45 dBC; SIG INDEP., <-60 dBm; 0.95 - 2.45 GHz out, G _{max}				
Spurious, Out of band	<-55 dBm, 0.5 - 0.95 GHz and 2.45 - 3.0 GHz; at G _{max}				
Intermodulation	<-50 dBC for two carriers at 4 MHz spacing centered on F _c , each at -5 dBm out; at G _{max}				
Frequency Response	±2.0 dB, 0.95 - 2.45 GHz; ±0.5 dB 40 MHz bandwidth out				
Frequency Sense	Non-inverting				
LO Characteristics					
LO Frequency	27.55 GHz				
Frequency Accuracy	± 0.05 ppm max. over temp internal reference; external reference input				
Phase Noise @ Freq (Hz)>	100 MHz	1 kHz	10 kHz	100 kHz	1 MHz
	dBC/Hz	-60	-70	-80	-90
10 MHz Level In/Mon.	+2 to +8 dBm in; Monitor Output = input level ± 1.0 dB, 50 ohms				
Controls, Indicators					
Gain, 10M Frequency	Gain and internal 10 MHz frequency via Ethernet M&C or Status/Control Connector.				
PLL Alarm	Red LED, External contact closure				
Power	Green LED				
Other					
Size	8" Wide X 6" High X 16" Deep Weather Resistant* Enclosure				
Power	100-400 ±10% VAC, 47 - 63 Hz, 25 watts maximum				
Option W74MKA	0 dB Input Monitor				
**+0 to +50 degrees C; Specifications subject to change without notice.			© 2021 Cross Technologies, Inc.		
Connectors*	Connector Part #	Mating Connector Part #	Additional Connector Specifications*		
Status/Control Connector	MS3112E14-18S	MS3116F14-18P	RF In, RF Mon.	L-Band	10MHz
Ethernet Connector/RJ45	RJF21B	RJF6G	2.92 mm	Type N	SMA
AC Input Connector**	CL1M1102	CL1F1101	Female; 50Ω	(Female) 50Ω	(Female), 50Ω

*All Connectors are Weather Resistant

2.0 Installation

The 4116-285-2450 Block Downconverter consists of a 8"W X 6"H X 16"D Weather Resistant* enclosure.

A switching, ± 12 , +24, +5 VDC power supply provides power for the internal assemblies.

The 4116-285-2450 can be secured to a mounting plate using the 4 holes on the bottom of the front and rear panels.

(See Figure 2.5 for mounting dimensions.)

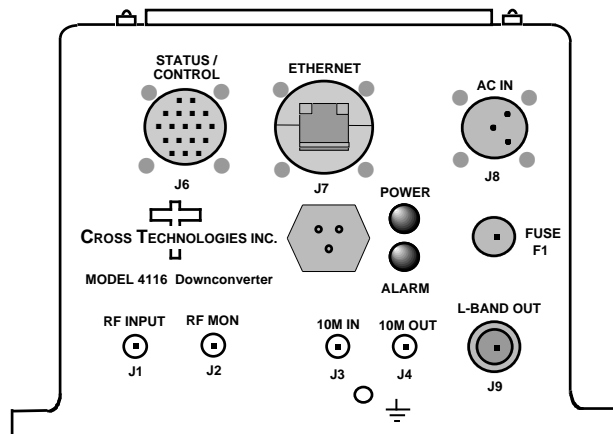

Figure 2. 4116-285-2450 Block Downconverter Front Panel Configuration

2.0.1 Connection to AC Input Power

The 4116-285-2450 is furnished with a pre-assembled AC power input cable as described below.

4116-285-2450 Power Input Connector, FCI Clipper Series	
Mating Connector FCI Clipper Series, CL1F1101, Crimp Pins	
and CL101021 Backshell	
Pin	Input Connector Pin Description
1	100-240 \pm 10% VAC, 47-63 Hz, 20 watts max.
2	Neutral
3	Ground

2.1 Message Protocol

The serial format for the RS232/RS422/RS485 port is 9600 baud, 8 data bits, no parity, and 1 stop bit.

All messages consist of ASCII printable characters so standard terminals and terminal emulator programs may be used to control and monitor the unit. All messages begin with the open bracket character “{” (ASCII 0x7B) and end with the close bracket character “}” (ASCII 0x7D). Messages consisting of commands to set or change operating parameters and modes of the unit begin with “C” (ascii 0x43) followed by a command specific character. Messages consisting of queries to report operating parameters and modes begin with “S” (ASCII 0x53) followed by a parameter specific character.

2.2 M&C Commands

The following tables summarize the commands and status queries applicable to the 4116-285-2450 frequency converter.

* **PLEASE NOTE:** The two character {aa} prefix, shown in the table below, is present ONLY when RS485 is selected.

Table 2.0 - Model 4116-285-2450 Block Downconverter M&C Commands

Table 2.0: Model 4116-285-2450 M&C Commands		
Command	Syntax	Description
Set Gain	{aaCGxxx}	where:
		xxx = 3 characters
		Range: 000 to 300 (00.0 to 30.0 in 0.5 dB steps)
Set Serial Interface	{aaCIx}	where:
		x = 0 to select RS232
		x = 1 to select RS422
		x = 2 to select RS485
Set RS485 address	{aaCRxx}	where:
		xx = 2 characters
		Range: 00 to 31
Set Int. 10 MHz reference offset	{aaCOxxxxx}	where:
		xxxxx = 5 characters
		Range: +2000 to -2000
Set 10 MHz reference mode	{aaCEx}	where:
		x = 1 to select internal reference
		x = 2 to select external reference
		x = 3 to select auto reference

2.3 M&C Queries

Table 2.1 - Model 4116-285-2450 Block Downconverter M&C Queries

Table 2.1: Model 4116-285-2450 M&C Queries		
Queries	Syntax	Description
Gain	{aaSG}	Returns {aaSGxxx} where: xxx = 3 characters Range: 300 to 000 (+30 to 0 dB) Example: {aaSG245} indicates the current gain setting is 24.5 dB
Serial Interface	{aaSI}	Returns {aaSIx} where: x = 0 if RS232 is selected x = 1 if RS422 is selected x = 2 if RS485 is selected
RS485 address	{aaSR}	Returns {aaSAxx} where: xx = 2 characters Range: 00 to 31
Int. 10 MHz reference offset	{aaSO}	Returns {aaSOxxxxx} where: xxxxx = 5 characters Range: -2000 to 2000
Unit Status	{aaSA}	Returns {aaSAxy} where: x = 0 if no summary alarm, x = 1 if summary alarm y = 0 if unit is using internal 10 MHz ref, y = 1 if unit is using external reference
Internal Temperature	{aaST}	Returns {aaSTxxx} where: xxx = 3 characters Range (-99 to +99) degrees Celsius
Model and firmware revision	{aaSV}	returns {aaSVxxxxxxxxxyyy} where: xxxxxxxx = unit model number yyy = unit firmware rev.

2.4 ETHERNET Interface Installation and Operation

The 4116-285-2450 Block Downconverter is equipped with a 10/100 Base-T compatible Ethernet interface for control and monitoring of its operating parameters. An HTML script interface allows the user to monitor and control the converter using a standard web browser. SNMP (Simple Network Management Protocol) is also supported. Contact Cross Technologies for the SNMP MIB file.

2.4.1 Methods of Connection

Directly Connected to a PC:

For control from a local PC, attach the 4116-285-2450's Ethernet port to the Ethernet network connector on the PC using a crossover RJ-45 cable.

LAN Connection:

For LAN connections, attach the 4116-285-2450 Ethernet port to the LAN using a normal RJ-45 cable. Use any PC on the LAN to connect to the 4116-285-2450.

2.4.2 Ethernet Configuration

Each 4116-285-2450 must be configured with an appropriate IP address, Netmask, and Gateway assigned by your network manager. The 4116-285-2450 is set at the factory with a static address of 192.168.123.2. The device server in the 4116-285-2450 has a built in HTTP based configuration manager that is used to configure network settings. To access the configuration manager, open a web browser and enter the IP address of the 4116-285-2450 in the browser's address field. The window shown in Figure 2-A will appear. As delivered, there is no password set. Choose your user name and password here or leave those fields blank and click OK to proceed to the configuration manager web page.



Figure 2-A: Password Screen

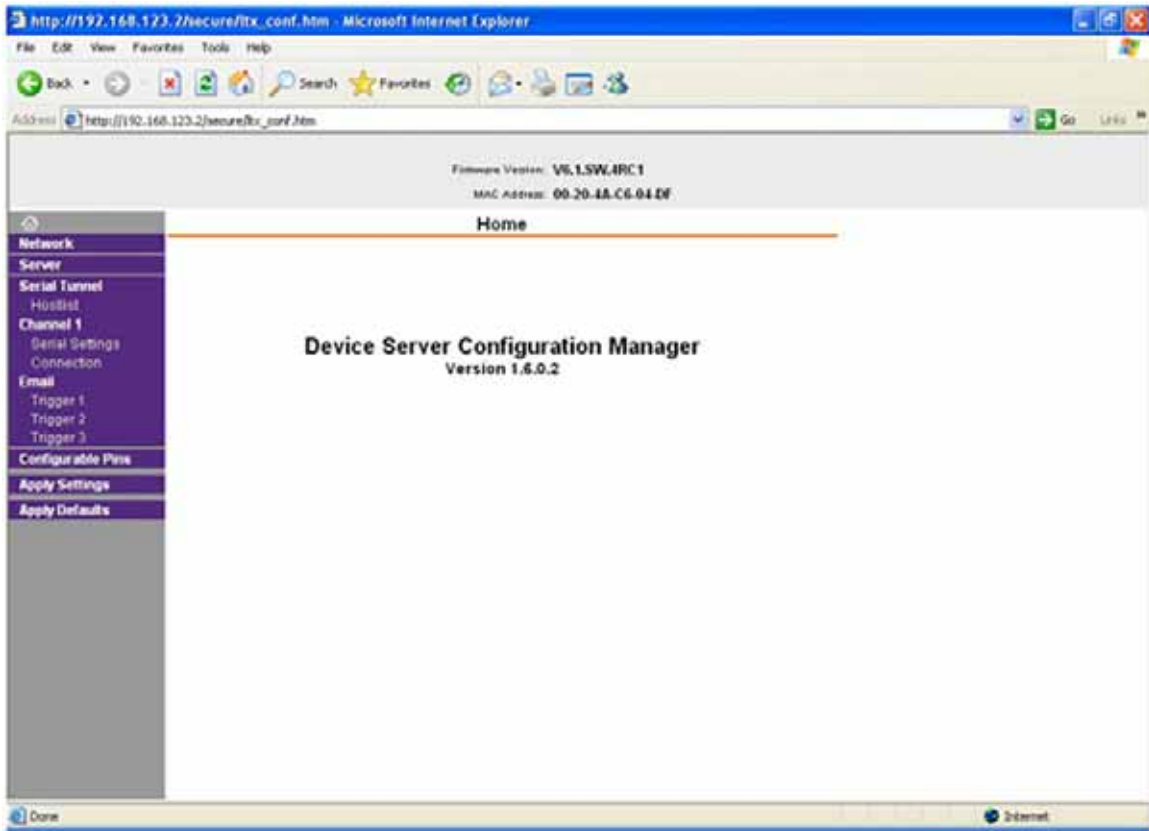

Figure 2-B: Configuration Manager Screen

In the left frame of the configuration manager, click on Network to display the Network Settings screen. Enter the IP address, Subnet mask, and Gateway address with delimiter dots (example: 192.168.192.47). Click on apply settings to apply the new settings in the device server.

2.4.3 Web page M & C

Enter the following address in a web browser to access the M & C web page:

http://<ip address of 41xx>/serial/0/setup.htm where <ip address> is the IP address of the unit.

Figure 2-C (page 11) shows the web page from a model 4116-285-2450 frequency converter.

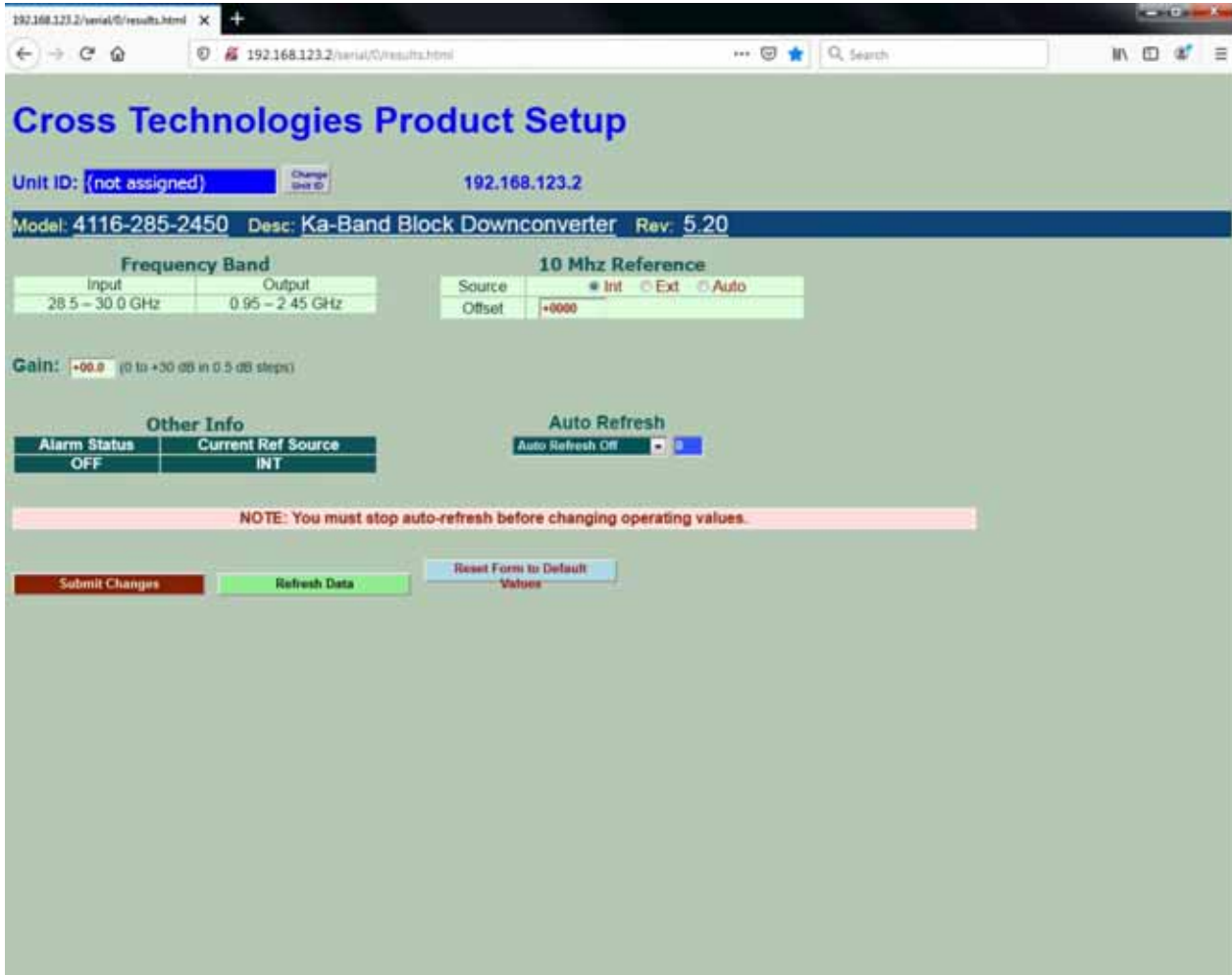

Figure 2-C - Model 4116-285-2450 Web Page

2.4.4 SNMP Configuration

Setting of SNMP parameters such as Community Write and Community Read strings requires a *Telnet*[®] connection to port 9999. The following instructions explain how to establish such a *Telnet*[®] connection using Windows XP's Hyper Terminal utility.

Start the Hyper Terminal application and select “New Connection” from the “File” drop down menu. The next screen is a “Connect To” dialog box. Select TCP/IP (Winsock) from the “Connect” using drop down menu.

Enter the IP address of the 4116-285-2450 in the “Host address:” field and 9999 in the “Port number” field. Figure 2-E shows an example of the Hyper Terminal settings required to access the SNMP configuration menu.



Figure 2-E: - Telnet[®] Settings in Hyper Terminal

Once the *Telnet*[®] connection is established you will be prompted to “Press Enter for Setup Mode.” Press enter and a menu of device server configuration options will appear (see Figure 2-F). Select menu item 3, “SNMP configuration.” You will be prompted to enter SNMP community read and write strings. After setting your desired community strings you will be prompted to “Enter IP addresses for SNMP traps”. You must enter at least one and up to four IP addresses of SNMP managers that will access the unit. This is required even though SNMP traps are not implemented. The unit will not process SNMP SET and GET requests from an SNMP manager unless the IP address associated with that manager is entered in the device server.

Figure 2-F - Device Server Configuration Menu

```
xport_telnet_setup - HyperTerminal
File Edit View Call Transfer Help

Enhanced Password is disabled

***** Channel 1 *****
Baudrate 38400, I/F Mode 4C, Flow 00
CPU performance : Standard
Web RAM size 01000

***** SNMP Configuration *****
SNMP community name for read: public
SNMP community name for write: public
Trap IP addresses:
1: 192.168.123.1
2: 0.0.0.0
3: 0.0.0.0

Change Setup:
0 Server configuration
1 Channel 1 configuration
3 SNMP configuration
6 Security
7 factory defaults
8 exit without save
9 save and exit

Your choice ?

Connected 0:00:20 ANSIW TCP/IP SCROLL CAPS NUM Capture Print
```

Figure 2.5 Shows front panel input and output connections, top view and baseplate mounting dimensions.

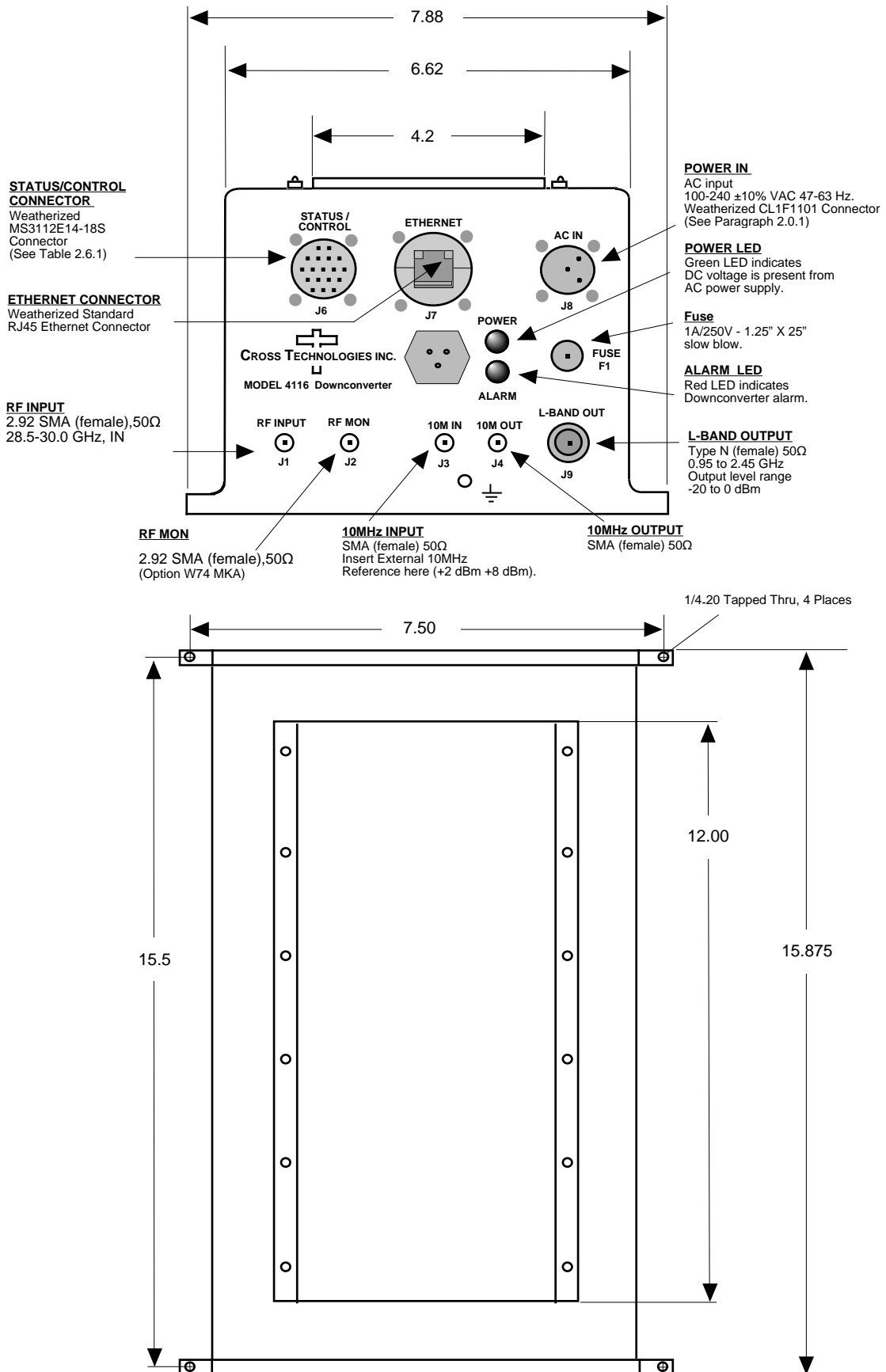

2.6 Physical Interface

All 4115 and 4116 units provide a RS232/RS422/RS485 interface port and a 10/100 Base-T Ethernet port. Both ports are available when the unit is installed and powered up. Commands may be sent to either port at any time and they will be processed in the order that they are received. The RS232/RS422/RS485 signals connect via an 18-pin MS3112E14-18S connector as shown in Table 2.6.1. The Ethernet signals connect via a standard RJ45 connector (RJF6G).

Table 2.6.1 - Monitor and Control Connector

Monitor and Control Connector Pinout	
Mating connector part number MS3112E14-18S	
Pin	Signal Description
A	Chassis Ground
N	Summary Alarm Normally Closed
P	Summary Alarm Common
R	Summary Alarm Normally Open
E	RS422/RS485 Data Out-
F	Signal Ground
C	RS422/RS485 Data In-
D	RS422/RS485 Data Out+, RS232 Data Out
B	RS422/RS485 Data In+, RS232 Data In

NOTE: Planning Ethernet Access

It is recommended that IP knowledgeable customer personnel be consulted as a resource in the installation and use of the Ethernet access features of the Cross Technologies product.

2.7 Installation/Operation

Installing and Operating the 4116-285-2450 Block Downconverter:

1. Connect a -50 dBm to -30 dBm signal to RF INPUT J1), (Figure 2.5).
2. Connect the L-BAND OUTPUT to the external equipment.
3. Using the pre-assembled AC power input cable (furnished), connect 100-240 \pm 10% VAC, 47 - 63 Hz to AC IN connector on the front panel.
4. If a custom length power cable must be made, refer to description below for connections*.
5. Be sure DS1 (green, DC Power) is on and DS2 (red, Alarm) is off (Figure 2.5).
6. Set the gain so that the output level is always within the range of +30 to 0 dBm.
(See Table 2.0 and 2.6.1).
7. Select either INT. (for internal 10 MHz ref), AUTO (for internal 10 MHz ref UNLESS an external 10 MHz, +2 to +8 dBm signal is connected to J2), or EXT (for external 10 MHz, +2 to +8 dBm reference that is inserted at J2) via Ethernet or serial command. (See Table 2.0 and 2.6.1).
8. Check that a 10 MHz, signal is present at the 10 MHz REF OUTPUT at the same level as the input, \pm 0.5 dB (J4 - Figure 2.5).
9. AC Fuse - The fuse is a 1A/250V, 1.25" x .25" (slow blow) and is inserted in the fuse F1 position.
NOTE: If a fuse continues to open, the power supply is most likely defective.

* 4116-285-2450 AC Power Input Connections	
Mating Connector, FCI Clipper Series, CL1M1102 and crimp pins	
Pin	Input Connector Pin Description
1	100-240 \pm 10% VAC, 47-63 Hz, 20 watts max.
2	Neutral
3	Ground



6170 Shiloh Road
Alpharetta, Georgia 30005

(770) 886-8005
FAX (770) 886-7964
Toll Free 888-900-5588

WEB www.crosstechnologies.com
E-MAIL info@crosstechnologies.com

Printed in USA