

Instruction Manual

Model 2005-02P4/03P4 Upconverters

August 2019, Rev. J

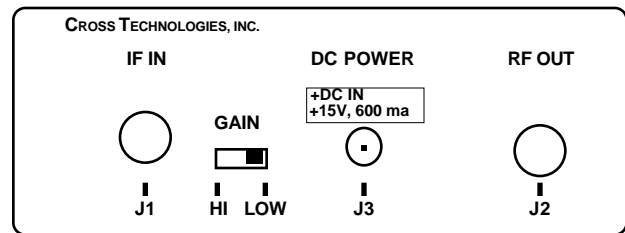
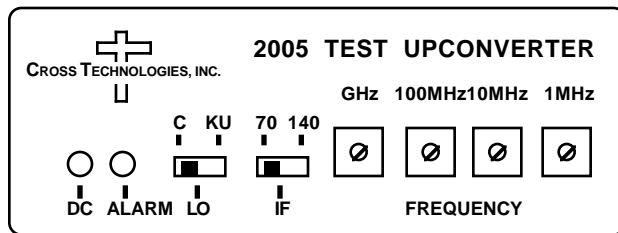

Data, drawings, and other material contained herein are proprietary to Cross Technologies, Inc., but may be reproduced or duplicated without the prior permission of Cross Technologies, Inc. for purposes of operating the equipment.

When ordering parts from Cross Technologies, Inc., be sure to include the equipment model number, equipment serial number, and a description of the part.



6170 Shiloh Road
Alpharetta, Georgia 30005

(770) 886-8005
FAX (770) 886-7964
Toll Free 888-900-5588

WEB www.crosstechnologies.com
E-MAIL info@crosstechnologies.com

INSTRUCTION MANUAL

MODELS 2005-02P4 and 2005-03P4 Upconverters

<u>TABLE OF CONTENTS</u>	<u>PAGE</u>
Warranty	2
1.0 General	3
1.1 Equipment Description	3
1.2 Technical Characteristics	4
2.0 Installation	5
2.1 Mechanical	5
2.2 Front Panel Controls and Indicators	5
2.3 Rear Panel Inputs, Outputs, and Controls	5
2.4 Accessing the PC Card	6
2.5 Operation	7
3.0 Environmental Use Information	8

WARRANTY - The following warranty applies to all Cross Technologies, Inc. products.

All Cross Technologies, Inc. products are warranted against defective materials and workmanship for a period of one year after shipment to customer. Cross Technologies, Inc.'s obligation under this warranty is limited to repairing or, at Cross Technologies, Inc.'s option, replacing parts, subassemblies, or entire assemblies. Cross Technologies, Inc. shall not be liable for any special, indirect, or consequential damages. This warranty does not cover parts or equipment which have been subject to misuse, negligence, or accident by the customer during use. All shipping costs for warranty repairs will be prepaid by the customer. There are not other warranties, express or implied, except as stated herein.



6170 Shiloh Road
Alpharetta, Georgia 30005

(770) 886-8005
FAX (770) 886-7964
Toll Free 888-900-5588

WEB www.crosstechnologies.com
E-MAIL info@crosstechnologies.com

MODELS 2005-02 and 2005-03 Agile Upconverters

1.0 General

1.1 Equipment Description

The 2005 Upconverters are typically used to loop 70 or 140 MHz IF modulators to L-band receivers. These IF signals must be “clean”(contain only the desired 70 or 140 MHz signal).

The 2005-02P4, for loop-back applications, converts a 70 MHz signal to a 950-2050 MHz output signal range in 1 MHz steps utilizing a high-side LO (C-band) that ranges from 1020 to 2120 MHz. The 2005-02 can also operate over a limited output frequency range converting a 70 MHz signal to 1090-2050 MHz utilizing a low-side LO (Ku-band), a 140 MHz signal to 950-1980 MHz utilizing a high-side LO, and a 140 MHz signal to 1160-2050 MHz utilizing a low-side LO.

The 2005-03P4, for loop-back applications, converts a 70 or 140 MHz signal to the full 950-1450 MHz output signal range in 1 MHz steps with either a high-side LO (C-band) or a low-side LO (Ku-band). The LO frequency ranges from 810 to 1590 MHz.

Featuring low phase noise, these units are used to loop 70 or 140 MHz modulators to L-band receivers in uplinks. The 70 or 140 MHz carrier input is mixed with a synthesized local oscillator (LO) signal. The output frequency is selected with four BCD switches which control the synthesized LO. Front panel LEDs light when DC power is applied (green) and when a PLL alarm occurs (red). The mixer output is applied to the output attenuator providing a nominal gain of -10 dB (high gain) or -30 dB (low gain). Power is provided by the LNB voltage from the receiver under test and connectors are BNC (female) for the IF input and type F (female) for the RF output. The 2005 can be powered by an external wall mount power supply **-P4**. The 2005 can be mounted on a 1 3/4”x 19”rack mount panel (**option -R**).

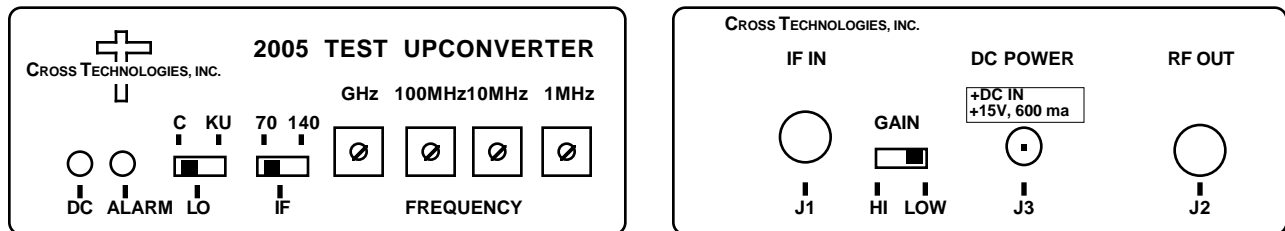

FIGURE 1.1 Front and Rear Panels

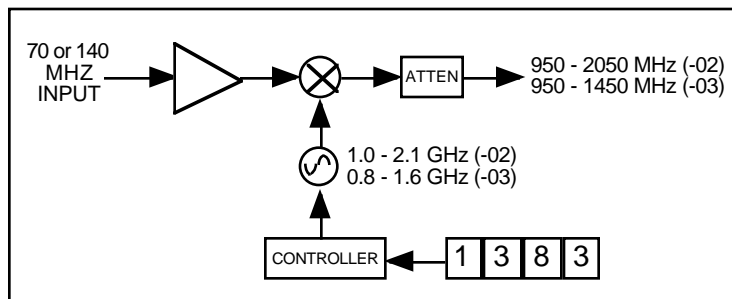

FIGURE 1.2 Block Diagram

1.2 Technical Characteristics

TABLE 1.1 2005 Upconverter Specifications

Input Characteristics

Impedance	75 Ω
Return Loss	12 dB
Frequency	70 or 140 MHz center
Input Level	-10 to -40 dBm
Input 1 dB comp / 3rd order	0 / +10 dBm (low gain), -20 / -10 dBm (high gain)

Output Characteristics

Impedance	75 Ω
Return Loss	8 dB
Frequency Band	950 -2050 MHz (-02) 950 -1450 MHz (-03)

Channel Characteristics

Gain (at 1200 MHz)	-20 dB \pm 3 dB(low gain) -5 dB \pm 3 dB(high gain)
Spurious Response	NA; output not filtered
Frequency Response	\pm 4 dB, 950 -2050 MHz; \pm 0.5 dB, any 10 MHz increment (-02) \pm 3 dB, 950 -1450 MHz; \pm 0.5 dB, any 10 MHz increment (-03)

Synthesizer Characteristics

Frequency Accuracy	\pm 25 kHz max
Frequency Step	1.0 MHz minimum

Phase Noise @ Freq	10kHz	100kHz	1MHz
dBC/Hz	-80	-90	-100

Controls

L-Band Frequency Selection	BCD switches with direct readout
LO Selection	SPDT slide switch
IF Frequency Selection	SPDT slide switch

Indicators

DC Power	Green LED
Alarm	Red LED

Other

RF Connector	F type (female)
IF Connector	BNC (female)
Size, Bench Top	4.7" wide X 1.75" high X 6.5" deep
Size (option -R)	19-inch standard 1RU chassis 1.75"H x 7.0"D
Power, Standard (P4)	100-240 \pm 10% VAC, 47-63Hz (+15VDC unregulated, 600 ma.) Wall Mount PS (Specify US, EUR, AUS, or UK)

Power Supply Option:

Power (option C)	No power supply. Requires external 2000-01 power supply.
---------------------------	--

*+10°C to +40°C; 2000 meters max elevation; 80% max humidity; Pollution Degree 2; Specifications subject to change without notice.

2.0 Installation

2.1 Mechanical

The 2005 is packaged in an aluminum extrusion. The **-R option** is mounted on a 1 3/4" X 19" panel that can be mounted to a rack using the 4 holes at the ends. Both units derive +DC from the RF out center conductor (+14 to +20 VDC) or the wall power supply (+15VDC unregulated). See Figure 2.3.

2.1.1 Cleaning Instructions

Wipe the exterior with a dry, soft cloth. Use no detergent or cleaning chemicals.

2.2 Front Panel Controls and Indicators

Figure 2.1 shows the controls and indicators located on the front panel.

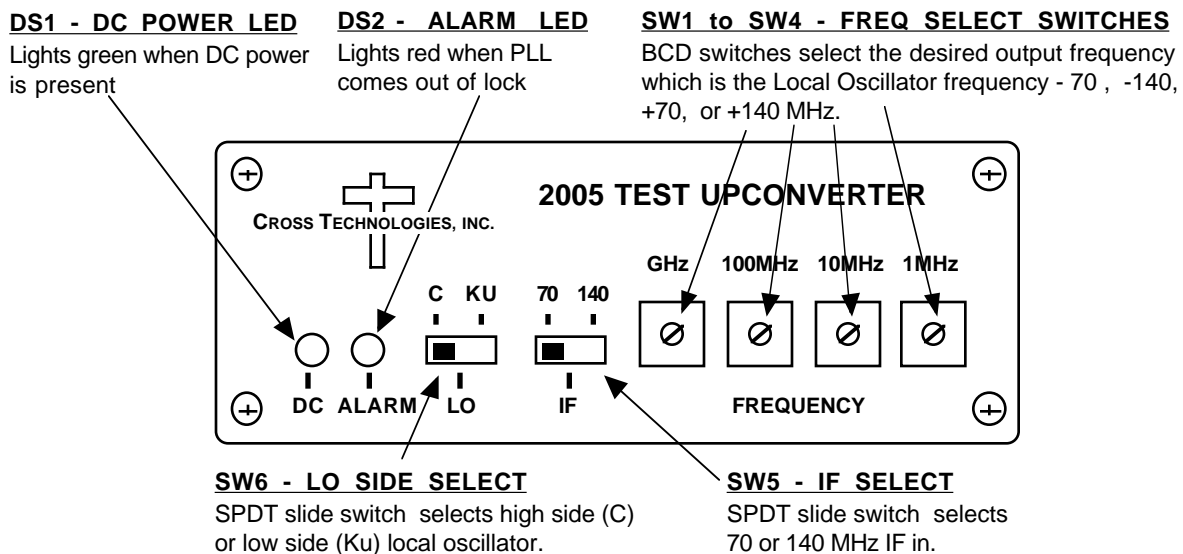

FIGURE 2.1 Front Panel Controls and Indicators

2.3 Rear Panel Inputs, Output, and Controls

Figure 2.2 shows the inputs, outputs, and controls located on the rear panel of the 2005.

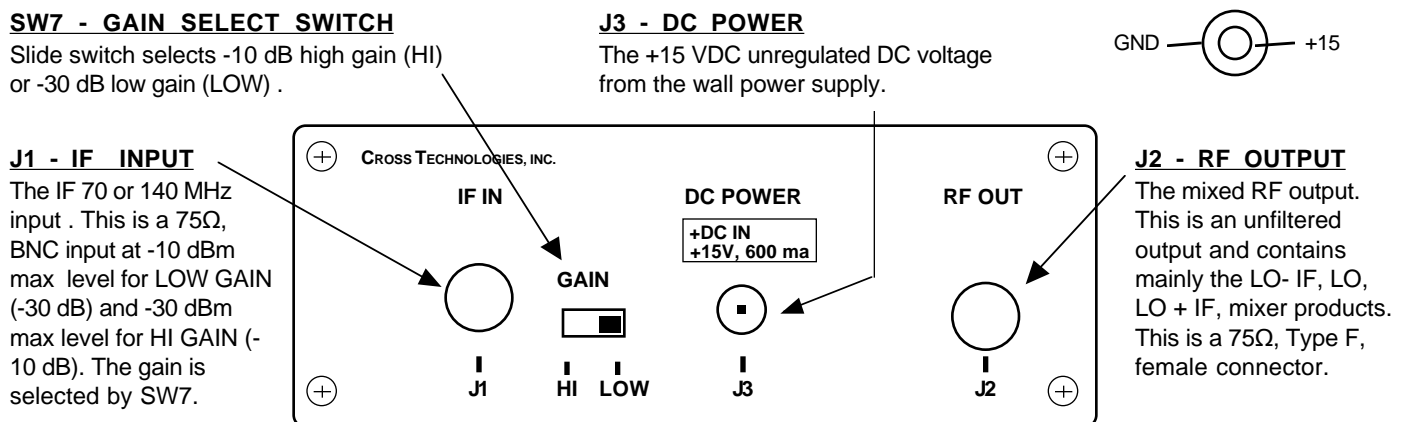

FIGURE 2.2 Rear Panel Inputs, Outputs, and Controls

2.4 Accessing the PC Card

There are NO USER JUMPERS or other on-card controls. ALTHOUGH IT IS NOT RECOMMENDED AND MAY VOID THE WARRANTY the following explains how to remove the printed circuit board (PCB) from the extrusion:

1. **Always remove power** when installing or removing the PCB from the extrusion
2. Remove four (4) **rear panel screws** (see Figure 2.3).
3. **Gently** pull the rear panel and PCB assembly completely out of the extrusion.
4. To install the PCB **gently** push the rear panel and PCB assembly completely into the extrusion. Make sure the shield goes in the lower channel and the PCB in the next channel above that in the extrusion and that the front panel controls go through the front panel holes.
5. Install four (4) **rear panel screws**.

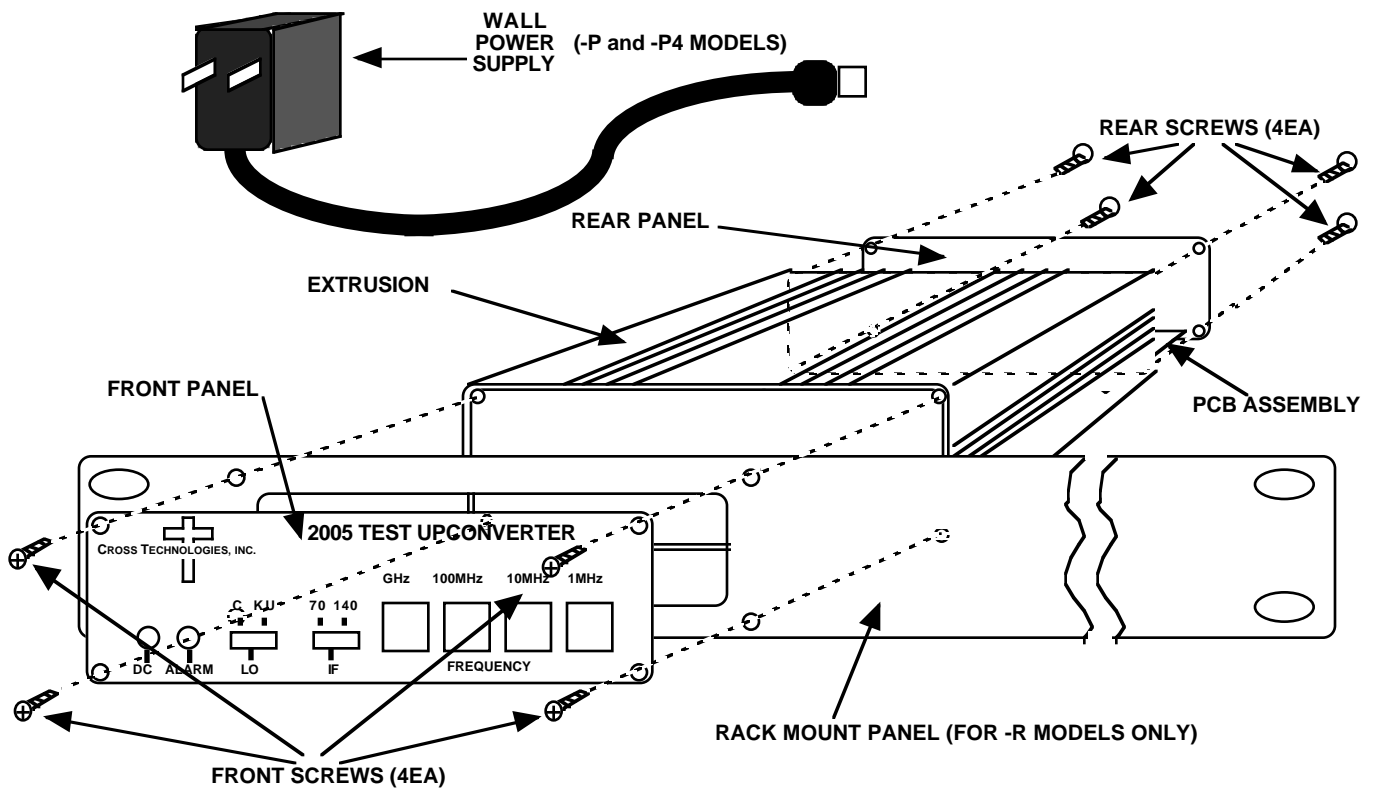

FIGURE 2.3 2005 Assembly Drawing

2.5 Operation

2.5.1 Installing and Operating the 2005

1. Check that SW5, SW6, SW7 are set to the desired positions (Figures 2.1 and 2.2).
2. If using the receiver LNB voltage to power the 2005, be sure +14 to +20 VDC is present on the RF OUT center conductor (Figure 2.2).
3. If using the wall power supply, connect one end to the 2005 and the other end to 100-240 \pm 10% VAC, 47-63 Hz (Figure 2.2)
4. Connect a -10dBm, max (LOW GAIN), or -30dBm, max (HI GAIN) signal to IF IN, J1 (Figure 2.2)
5. Connect the RF OUT, J2, to the receiver under test (Figure 2.2).
6. Set BCD switches SW1 to SW4 to the desired L-band frequency (Figure 2.1).
7. Be sure DS1 (green, DC Power) is on and DS2 (red, ALARM) is off (Figure 2.1).

2.5.2 Frequency Setting, SW1 to SW4

The frequency is selected by setting the BCD switches (SW1 to SW4) on the front panel to the desired frequency using a small blade screwdriver. The frequency displayed on the BCD switches is the desired output frequency with 70 or 140 MHz IF center frequency input and the low or high side LO as selected by SW5 and SW6 (see Figure 2.2). There is no muting of the output carrier during frequency selection. If the switches are set to an invalid frequency, alarm LED DS2 will light.

2.5.3 LO and IF for the 2005-02P4

The 2005-02 operates over it's full 950 to 2050 MHz range with high side LO and 70 MHz input. Normally, LNB's use high side LO for C-band and low side LO for Ku-band. Also, note that there will be a spectrum inversion of the input IF modulation with the high side LO. Although the 2005-02 operates over it's full 950 to 2050 MHz range with high side LO and 70 MHz input only, it can be set for low side LO and 140 MHz operation over a limited range as Table 2.1 shows. The PLL will alarm if you try to operate the 2005-02 outside the allowable frequency range shown.

2.5.4 LO and IF for the 2005-03P4

The 2005-03 operates over it's full 950 to 1450 MHz range with high side or low side LO and 70 or 140 MHz input as shown in Table 2.1. Normally, LNB's use high side LO for C-band and low side LO for Ku-band. Also, note that there will be a spectrum inversion of the input IF modulation with the high side LO.

TABLE 2.1 2005 UPCONVERTER FREQUENCY INFORMATION					
		2005-02	2005-02	2005-03	2005-03
LO-Side	IF (MHz)	LO Range (MHz)	Output Range (MHz)	LO Range (MHz)	Output Range (MHz)
HIGH	70	1020-2120	950-2050	1020-1520	950-1450
LOW	70	1020-1980	1090-2050	880-1380	950-1450
HIGH	140	1090-2120	950-1980	1090-1590	950-1450
LOW	140	1020-1910	1160-2050	810-1310	950-1450

2.5.5 Selecting High/Low Side LO, 70/140 MHz IF, and Gain

To select high- or low-side LO and 70 or 140 MHz IF Input set SW5 and SW6 on the front panel (see Figure 2.1) to the desired position. The gain of the 2005 can be selected for -10 dB (HI gain, -30 dBm maximum IF input) or -30 dB (LOW gain, -10 dBm maximum IF input) with SW7 on the rear panel (see Figure 2.2).

3.0 Environmental Use Information

- A. Elevated operating ambient temperature** - if installed in a closed or multi-unit rack assembly, the operating ambient temperature of the rack may be greater than room ambient temperature. Therefore, consideration should be given to Tmra (Maximum Recommended Ambient Temperature).
- B. Reduced air flow** - Installation of the equipment in a rack should be such that the amount of air flow required for safe operation of the equipment is not compromised. Additional space between units may be required.
- C. Mechanical loading** - Mounting of equipment in a rack should be such that a hazardous condition does not exist due to uneven weight distribution.
- D. Circuit Overloading** - Consideration should be given to the connection of the equipment to the supply circuit and the effect that overloading of circuits could have on over current protection and supply wiring. Appropriate consideration of equipment name plate rating should be used, when addressing this concern.
- E. Reliable Earthing** - Reliable earthing of rack-mounted equipment should be maintained. Particular attention should be given to supply connections other than direct connection to the Branch (use of power strips).
- F. Top Cover** - There are no servicable parts inside the product so, the Top Cover should not be removed. If the Top Cover is removed the ground strap and associated screw **MUST BE RE-INSTALLED** prior to Top Cover screw replacement. **FAILURE TO DO** this may cause **INGRESS** and/or **EGRESS** emission problems.



6170 Shiloh Road
Alpharetta, Georgia 30005

(770) 886-8005
FAX (770) 886-7964
Toll Free 888-900-5588

WEB www.crosstechnologies.com
E-MAIL info@crosstechnologies.com

Printed in USA